

DESCRIPTION

CS1-PR **economic** type Process Indicator has been designed with high accuracy measurement, display and communication of **DC signal 0~10V and 4(0)~20mA**. They are also available 1 option of 1 Relay outputs, 1 Analogue output or 1 RS485(Modbus RTU Mode) interface with versatile functions such as control, alarm, re-transmission or communication for a wide range of industrial applications.



FEATURE

- Measuring linear signal 0~10V and 0(4)~20mA in one indicator(input code: AV)
- Square Root function available by programming
- Option available 1 of 1 relay, 1 analogue output or RS485(Modbus RTU mode)
- 1 relay can be programmed individual to be a Hi / Lo / Hi Latch / Lo Latch energized with Start Delay / Hysteresis / Energized & De-energized Delay functions.
- Analogue output or RS 485 communication port in option
- CE Approved & RoHS

ORDERING INFORMATION

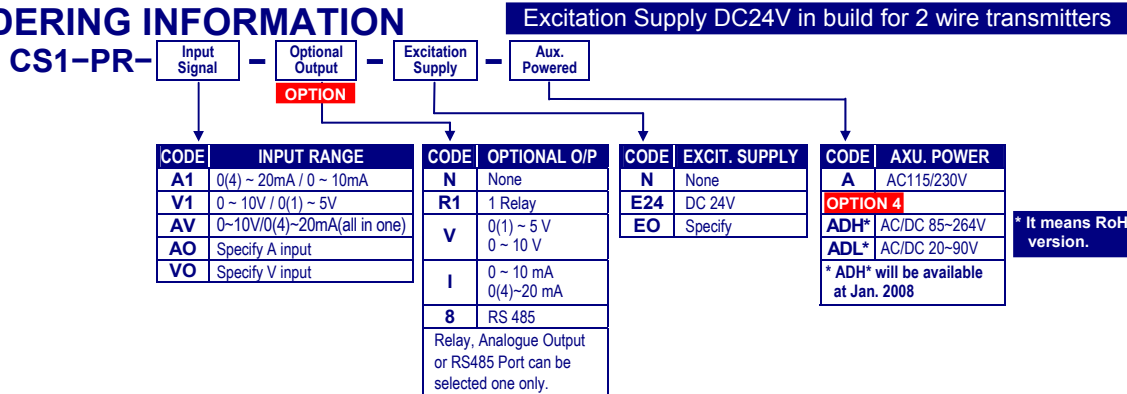

TECHNICAL SPECIFICATION

Input

Input Range	Input Impedance	Input Range	Input Impedance
Voltage 0 ~ 10 V	≥ 1M ohm	Current 4(0)~20 mA	250 ohm

➤ The Meter can be 0~10V and 0~20mA in one unit, according to connection #11 or #12

Calibration: Digital calibration by front key
A/D converter: 16 bits resolution
Accuracy: $\pm 0.04\%$ of FS $\pm 1\text{C}$;
Sampling rate: 15 cycles/sec
Response Time: ≤ 100 msec.(when the AvG = "1") in standard
Input type: 0~10V / 0~5V / 1~5V / 0~10mA / 0~20mA / 4~20mA programmable for coding AV(option)

Display & Functions

LED: Numeric: 5 digits, 0.8"(20.0mm)H red high-brightness LED
 Relay output indication: 1 square red LED
 RS 485 communication: 1 square orange LED
 E.C.I. function indication: 1 square green LED
 Max/Mini Hold indication: 2 square orange LED
 Down key function indication(Reset for Max.(Mini.) Hold / PV Hold / Rel. PV): 1 square green LED

Display range: -19999~29999;
Scaling function: Lo.SC: Low Scale; Settable range: -19999~+29999
 Hi.SC: High Scale; Settable range: -19999~+29999
 Programmable from 0 / 0.0 / 0.00 / 0.000 / 0.0000

Decimal point: ovFL, when input is over 120% of input range Hi
 Under range indication: -ovFL, when input is under -20% of input range Lo
 Maximum and Minimum value storage during power on.

Display functions: PV / Max(Mini) Hold / RS 485 Programmable
Front key functions: Relative PV / PV Hold / Reset for maxi(mini) hold / Reset for relay energized latch programmable
 Settable range: -19999~29999 counts

Low cut:

Digital fine adjust: Pv.Zro: Settable range: -19999~+29999
 Pv.SPn: Settable range: -19999~+29999

Reading Stable Function

Average: Settable range: 1~99 times
Moving average: Settable range: 1(None)~10 times
Digital filter: Settable range: 0(None)/1~99 times

Control Functions(option)

Set-points: One set-point
Control relay: 1 Relay, FORM-C, 5A/230Vac, 10A/115V
Relay energized mode: Energized levels compare with set-points:
Hi / Lo / Hi.HLd / Lo.HLd programmable
Energizing functions: Start delay / Energized & De-energized delay / Hysteresis
 Energized Latch
Start band(Minimum level for Energizing): 0~9999counts
Start delay time: 0:00.0~9(Minutes):59.9(Second)
Energized delay time: 0:00.0~9(Minutes):59.9(Second)
De-energized delay time: 0:00.0~9(Minutes):59.9(Second)
 Hysteresis: 0~5000 counts

Analogue output(option)

Accuracy: $\leq \pm 0.1\%$ of F.S.;
Ripple: $\leq \pm 0.1\%$ of F.S.
Response time: ≤ 100 msec. (10~90% of input)
Isolation: AC 2.0 KV between input and output
Output range: Specify either Voltage or Current output in ordering
Voltage: 0~5V / 0~10V / 1~5V programmable
Current: 0~10mA / 0~20mA / 4~20mA programmable
Voltage: 0~10V: $\geq 1000\Omega$;
Current: 4(0)~20mA: $\leq 600\Omega$ max
Ao.HS(output range high): Settable range: -19999~29999
Ao.LS(output range Low): Settable range: -19999~29999
Ao.Zro: Settable range: -38011~+27524
Ao.SPn: Settable range: -38011~+27524

RS 485 Communication(option)

Protocol: Modbus RTU mode
Baud rate: 1200/2400/4800/9600/19200/38400 programmable
Data bits: 8 bits
Parity: Even, odd or none (with 1 or 2 stop bit) programmable
Address: 1 ~ 255 programmable
Remote display: to show the value from RS485 command of master
Distance: 1200M
Terminate resistor: 150Ω at last unit.

Electrical Safety

Dielectric strength: AC 2.0 KV for 1 min, Between Power / Input / Output / Case
Insulation resistance: ≥100M ohm at 500Vdc, Between Power / Input / Output
Isolation: Between Power / Input / Relay, Analogue, RS485
EMC: EN 55011:2002; EN 61326:2003
Safety(LVD): EN 61010-1:2001

Environmental

Operating temp.: 0~60 °C
Operating humidity: 20~95 %RH, Non-condensing
Temp. coefficient: ≤100 PPM/°C
Storage temp.: -10~70 °C
Enclosure: Front panel: IEC 549 (IP54); Housing: IP20

Mechanical

Dimensions: 96mm(W) x 48mm(H) x 72mm(D)
Panel cutout: 92mm(W) x 44mm(H)
Case materiel: ABS fire-resistance (UL 94V-0)
Mounting: Panel flush mounting
Terminal block: Plastic NYLON 66 (UL 94V-0)
 10A 300Vac, M2.6, 1.3~2.0mm²(16~12AWG)
 350g / 300g(Aux. Power Code: ADH or ADL)

Power

Power supply: AC115/230V,50/60Hz;
 Optional: AC/DC 85~264V or 20~90V(RoHS version)
Excitation supply: DC24V/30mA maximum in standard
Power Consumption: 4.5VA maximum
Back up memory: By EEPROM

FRONT PANEL

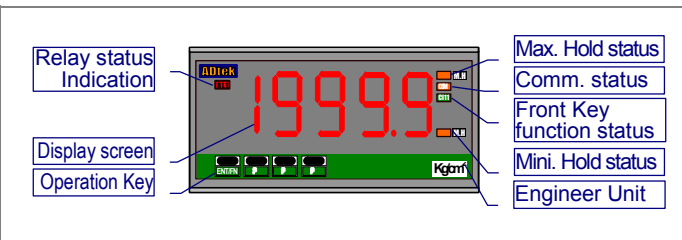

DIMENSIONS

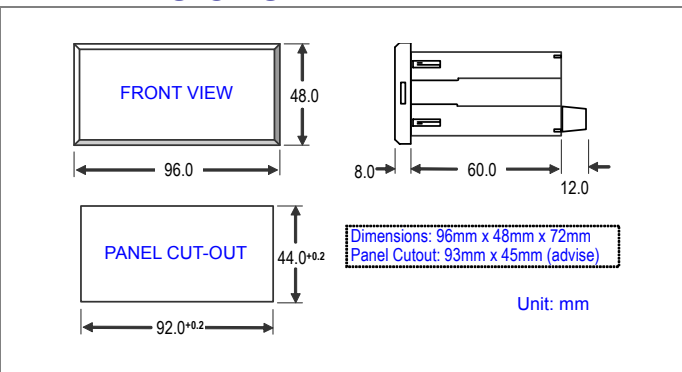

INSTALLATION

The meter should be installed in a location that dose not exceed the maximum operating temperature and provides good air circulation.

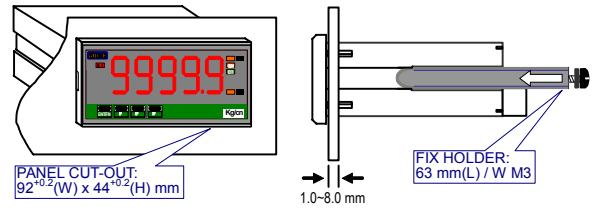

CONNECTION DIAGRAM

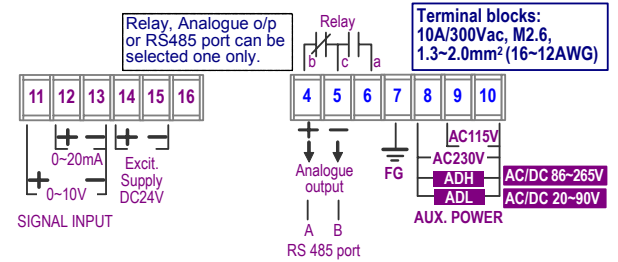

Please check the voltage of power supplied first, and then connect to the specified terminals. It is recommended that power supplied to the meter be protected by a fuse or circuit breaker.

Power Supply

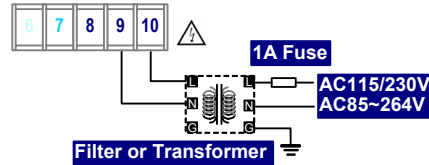

2 wire Transmitter connection

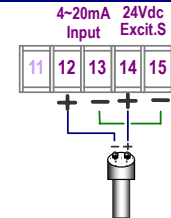

RS485 Communication Port

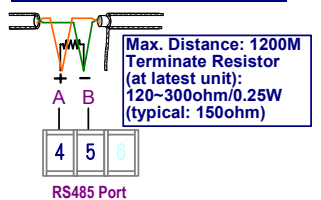

FUNCTION DESCRIPTION

Input & Scaling Functions

Dual input types: (Option Code: AV)

Voltage and Current Type are in one unit available in option. If the customer specify the input coding for AV, the meter will be calibrated for 0~10V and 0~20mA in factory. The user can use in 0~10V or 4(0)~20mA by difference terminals connection(#11 & #13 for 0~10V or #12 & #13 for 4(0)~20mA) and programming in [Ai.TYP] of [inPUt GroUP] .

Scaling function:

Setting the **Lo.SC**(Low scale) and **Hi.SC**(High scale) in [inPUt GroUP] to relative input signal. **Reverse slop** will be done too. Please refer to the figure as below,

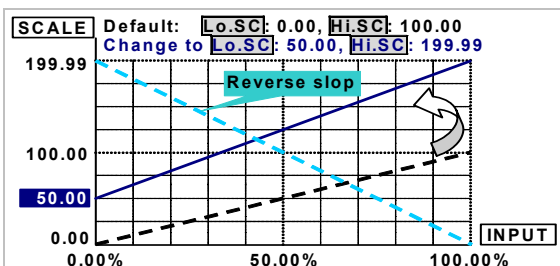

*Too narrow scale may course display lower resolution.

Display & Functions

Max / Mini recording:

The meter will storage the maximum and minimum value in [User Level] during power on in order to review drifting of PV.

Display functions:

(Please refer to step A-07)

PV / Max(Mini) Hold / RS 485 programmable in

[dSPly] function of [inPUt GroUP]

Present Value [PV]: The display will show the value that Relative to Input signal.

Maximum Hold [Max.H] / Minimum Hold [Mini.H]:

The meter will keep display in maximum(minimum) value during power on, until press front key to reset (If the down key function in [inPUt GroUP] has been set to [M.rSt].)

- Please find the  sticker that enclosure the package of the meter to stick on the right side of square orange LED

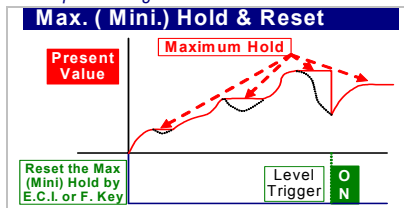



Remote Display by RS485 command [RS485]: The meter will show the value that received from RS485 sending. In past, The meter normally receive or 0~10V from AO or digital output from BCD module of PLC. We support a new solution that PV shows the value from RS485 command of master can so that can be **save cost and wiring** from PLC.

Front key functions:



Relative PV / PV Hold / Reset for maxi(mini) hold /

Reset for relay energized latch programmable in

[dn.KEY] function of [inPUt GroUP]

Relative PV [REL.PV]: [dn.KEY] function can be set to be [REL.PV] function. When user press the  key, the display will show the differential value(ΔPV), until press  key again.

- Please find the  sticker to stick on the right side of square red LED.

PV Hold [Pv.HLd]: [dn.KEY] function can be set to be [Pv.HLd] function. When user press the  key, the display will be hold until press the  key again.

- Please find the  sticker to stick on the right side of square red LED.

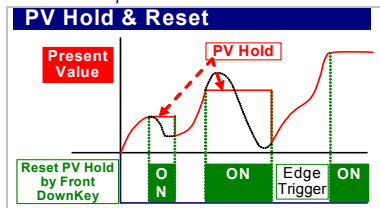

Reset for Max(Mini) Hold: when the [dSPly] in [inPUt GroUP] set to be [Max.H] or [Mini.H], [dn.KEY] function can be set to be [M.rSt] to reset the display when it is holding in maxim or mini value.

Reset for relay energized latch: when the [rY1.Md] in [rELAY GroUP] set to be [Hi.HLd] or [Lo.HLd], [dn.KEY] function can be set to be [Y.rSt] to reset the relay when it is energizing and latching.

Low cut:

If the setting value is positive, it means when the absolutely value of $PV \leq \text{Setting value}$, the display will be 0. If the setting value is negative, it means when the PV under setting value ($PV \leq -\text{Setting value}$), the display will be setting value.

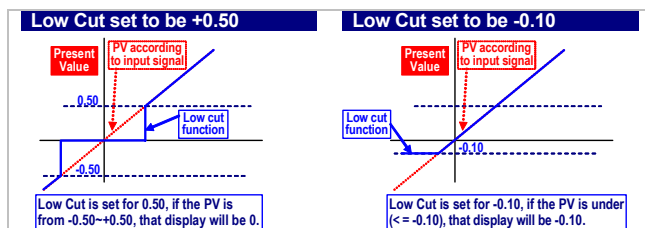

Digital fine adjustment:

Users can get Fine Adjustment for Zero & Span of PV by front key of the meter, and "Just Key In" the value which user want to show in the current input signals.

Especially, the [Pv.Zro] & [Pv.SPn] are not only in zero & span of PV, but also any lower point for [Pv.Zro] & higher point for [Pv.SPn]. The meter will be linearization for full scale.

The adjustment can be clear in function [Z.S.Clr].

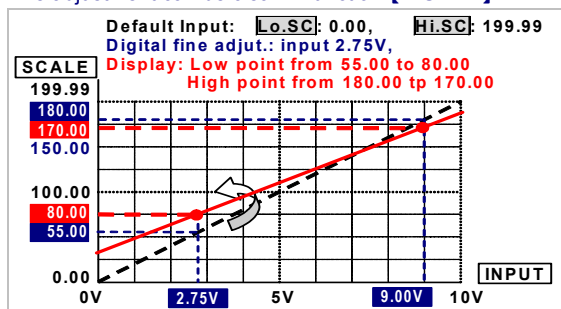

Reading Stable Function

Average:

Basically, the sampling rate of meter is 15cycles/sec. If the function set to be 3 times, It means the meter will update of display will be 5 times/sec.

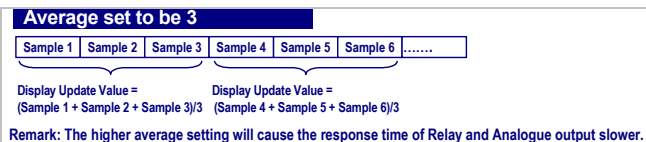

Remark: The higher average setting will cause the response time of Relay and Analogue output slower.

Moving average:

If the function to be set 3 times, the meter will update delay in first 3 samples, then it will update 15 times/sec continuously.

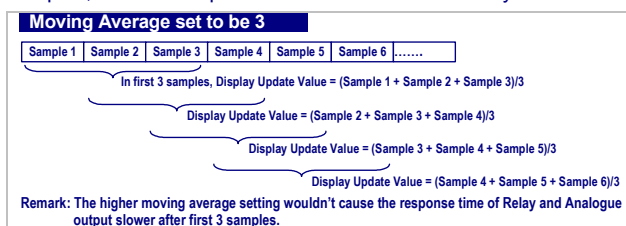

Remark: The higher moving average setting wouldn't cause the response time of Relay and Analogue output slower after first 3 samples.

Digital filter:

The digital filter can reduce the magnetic noise in field.

Control functions(option)

Relay energized mode: Hi/Lo/Hi.HLd/Lo.HLd programmable

Hi: Relay will energize when $PV > \text{Set-Point}$

Lo: Relay will energize when $PV < \text{Set-Point}$

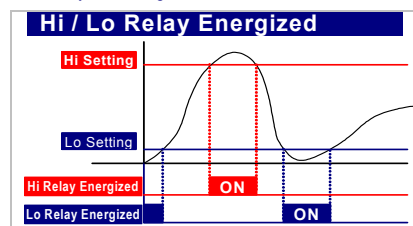

Hi.HLd (Lo.HLd): When the PV is Higher (or lower) than set-point, the relay will be energized and latch until manual reset by from key in [User Level] or press down key to reset (If the [dn.KEY] function set to be [Y.rSt]).

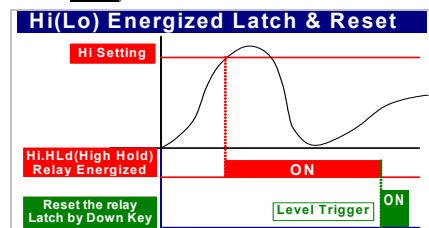

Energized functions: Start delay / Energized & De-energized delay / Hysteresis

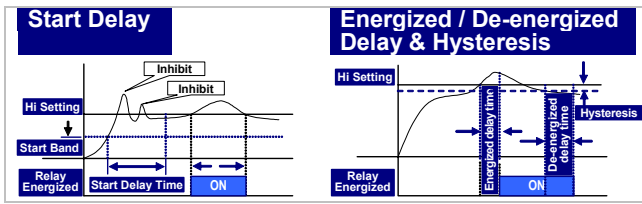

RS 485 Communication(option)

The RS485's protocol is Modbus RTU mode, and baud rate up to 38400bps. It's convenience to remote monitoring, display for reading.

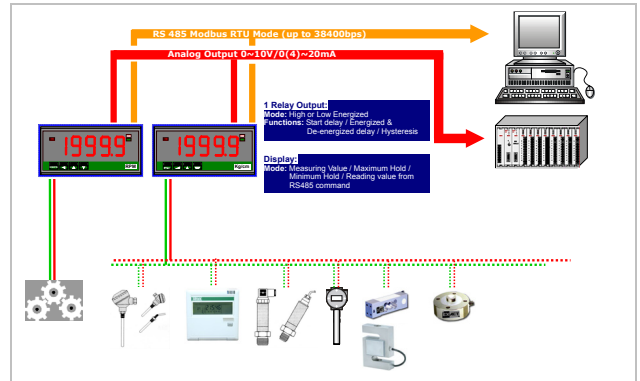

Analogue output(option)

Please specify the output type either an 0~10V or 4(0)~20mA in ordering. The programmable output low and high scaling can be based on various display values. Reverse slope output is possible by reversing point positions.

Output range: Voltage: 0~5V / 0~10V / 1~5V programmable
 Current: 0~10mA / 0~20mA / 4~20mA programmable
Functions: **Ao.HS**(output range high): setting the Display value High to versus output range High(as like as 20mA in 4~20)
Ao.LS(output range Low): setting the Display value Low to versus output range Low(as like as 4mA in 4~20)

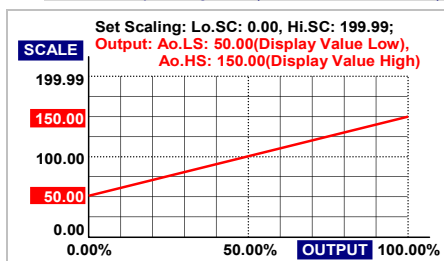

The range between Ao.HS and Ao.LS should be over 20% of span at least; otherwise, it will be got less resolution of analogue output.

Fine zero & span adjustment:

Users can get Fine Adjustment of analogue output by front key of the meter. Please connect standard meter to the terminal of analogue output. To press the front key(up or down key) of meter to adjust and check the output of meter.

- [Ao.Zro] : Fine Zero Adjustment for Analog Output; Settable range: -38011~27524;
- [Ao.Spn] : Fine Span Adjustment for Analog Output; Settable range: -38011~27524;

Remote display:

The meter will show the value that received from RS485 command. In past, The meter normally receive 4~20mA or 0~10V from AO or digital output from BCD module of PLC. We support a new solution that PV shows the value from RS485 command of master so that can be **save cost and wiring** from PLC.

When the [dSPLY] set to RS485, it means, the PV screen will show the number from RS485 command & data. The data(number) will be same as PV that will compare with set-point, analogue output and ECI functions so that is to control analogue output, relay energized and so on.

CS1 APPLICATION FOR REMOTE DISPLAY FROM RS485 COMMAND

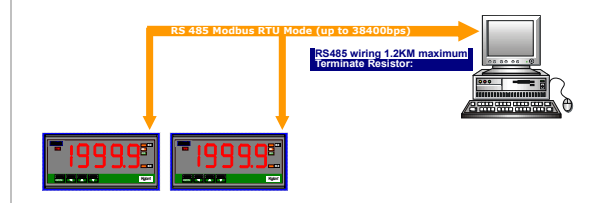

■ ERROR MASAGE

DESCRIPTION	DISPLAY	FLASH	REMARK
BEFORE POWER ON, PLEASE CHECK THE SPECIFICATION AND CONNECTION AGAIN.			
SELF-DIAGNOSIS AND ERROR CODE:			
ouFL : Display is positive-overflow (Signal is over display range)	ouFL		(Please check the input signal)
-ouFL : Display is negative-overflow (Signal is under display range)	-ouFL		(Please check the input signal)
ouFL : ADC is positive-overflow (Signal is higher than input 120%)	ouFL		(Please check the input signal)
-ouFL : ADC is negative-overflow (Signal is lower than input -120%)	-ouFL		(Please check the input signal)
E E P / F A I L : EEPROM occurs error	E E P	F A I L	(Please send back to manufactory for repaired)
A I C.n G / P u : Calibrating Input Signal do not process	A I C.n G	P u	(Please process Calibrating Input Signal)
A I C. / F A I L : Calibrating Input Signal error	A I C.	F A I L	(Please check Calibrating Input Signal)
A o C.n G / P u : Calibrating Output Signal do not process	A o C.n G	P u	(Please process Calibrating Output Signal)
A I C. / F A I L : Calibrating Output Signal error	A I C.	F A I L	(Please check Calibrating Output Signal)

CS1-PR

FRONT PANEL:

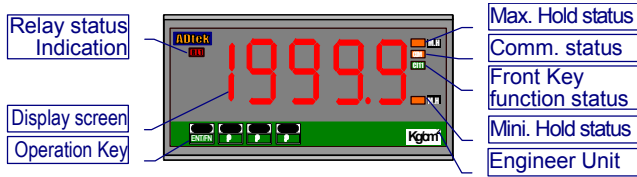

Numeric Screens

0.8"(20.0mm) red high-brightness LED for 5 digital present value.

I/O Status Indication

- **Relay Energized:** 1 square red LED
RL1 display when Relay 1 energized;
- **RS485 Communication:** 1 square orange LED
COM will flash when the meter is receive or send data, and **COM** flash quickly means the data transient quicker.
- **Max/Mini Hold indication:** 2 square orange LEDs
M.H displayed: When the display function has been selected in Maximum or Minimum Hold function.

Stickers:

Each meter has a sticker what are functions and engineer label enclosure.

- **Relay energized mode:** **HH Hi Lo LL DO**
- **Down key functions mode:**
PV.H PV.H(PV Hold) / **Tare** Tare / **DI** DI(Digital Input)
M.RS M.RS(Maximum or Minimum Reset) /
R.RS R.RS(Reset for Relay Latch)
- **Engineer Label:** over 80 types.

- **Operating Key:** 4 keys for **ENTER** Enter(Function) / **ESC** Shift(Escape) / **▲** Up key / **▼** Down key

	Setting Status	Function Index
▲ Up key	Increase number	Go back to previous function index
▼ Down key	Decrease number	Go to next function index
ESC Shift key	Shift the setting position	Go back to this function index, and abort the setting
ENTER Enter/Fun key	Setting Confirmed and save to EEPROM	From the function index to get into setting status

- **Pass Word:** Settable range:0000~9999;

User has to key in the right pass word so that get into **【 Programming Level 】**. Otherwise, the meter will go back to measuring page. If user forgets the password, please contact with the service window.

- **Function Lock:** There are 4 levels programmable.

- **None:** no lock all.
- **User Level:** User Level lock. User can get into User Level for checking but setting.
- **Programming Level:** Programming level lock. User can get into programming level for checking but setting.
- **ALL:** All lock. User can get into all level for checking but setting.

Front Key Function

- The **▼** Key can be set to be **rEL.Pv** / **Pv.HLd** / **M.rSt** / **rY.rSt** programmable.

OPERATING DIAGRAM (The detail description of operation, please refer to operating manual.)

Power ON

8888.8 Self-diagnosis

CS1Pr Show the model number

uEr 1.0 Show the firmware version

MEASURING PAGE
1688.8
Press 1sec →
← Press 2sec

Enter the password to access programming Level

Pass Code
NO
YES
Default:1000

User Level

Press for 1 sec. can back to Measuring

0-0-1	19999 Pv Pv: Present Value	This page will show out, when dSPly set to be RS485.	0-3	00000 Min:PV Minimum storage Checking only	0-6	CS1Pr uEr 1.0 model number firmware version Checking only
0-1	rY1SP 10000 rY1.SP.: Relay 1 Set-point setting -19999~+29999		0-4	00000 MAX:PV Maximum storage Checking only	0-0-1	19999 Pv Cyclic to first page
0-2	rYrSt no rYrSt: Reset for energized Latch of Relay YES no		0-5	no M.rSt: Reset for Maximum & Minimum storage YES no		

Programming Level

Press for 1 sec. can back to Measuring

GROUP input	INPUT GROUP	GROUP rELAY	RELAY GROUP	GROUP A0	ANALOGUE OUTPUT GROUP	GROUP rS485	RS485 GROUP
A-0	Ai.tYP: Analogue Input type selection v.0-10 v. 0-5 v.1-5 A.0-10 A.0-20 A.4-20	B-1	rY.Sb: Start band for Relay energized 0~9999counts	D-1	Ao.Tvp: Analogue Output type selection v.0-10 v. 0-5 v.1-5 A.0-20 A.4-20 A.0-10	E-1	Adres: Device number of the meter 1~255
A-1	Pv.dP: Decimal Point of PV 0~0.0000	B-2	rY.Sd: Start delay time for Relay energized 0:00.0~9(m):59.9(s)	D-2	Ao.LS: Analogue Low Output versus Low Scale -19999~+29999	E-2	baud: Baud rate 1200 2400 4800 9600 19200 38400
A-2	Lo.SC: Low scale of PV -19999~+29999	B-3	rY1.Md: Relay 1 energized mode oFF Lo Hi Lo.HLd Hi.HLd do	D-3	Ao.HS: Analogue High Output versus High Scale -19999~+29999	E-3	PrItY: Parity n.Stb.1 n.Stb.2 odd EvEn
A-3	Hi.SC: High scale of PV -19999~+29999	B-4	rY1.HY: Relay 1 Hysteresis 0~5000counts	D-4	Ao.Zro: Fine Zero Adjustment for Analogue Low Output -38011~+27524		
A-4	Pv.Zro: Fine Low point Adjustment for PV display -19999~+29999	B-5	rY1.rd: Relay 1 energized delay time 0:00.0~9(m):59.9(s)	D-5	Ao.SPn: Fine Span Adjustment for Analogue High Output -38011~+27524		
A-5	Pv.SPn: Fine High point Adjustment for PV display -19999~+29999	B-6	rY1.Fd: Relay 1 de-energized delay time 0:00.0~9(m):59.9(s)	D-6	Z.S.CLR: Zero & Span Clear for Adjustment nonE Ao.Zro Ao.SPn both		

Next Page

CS1-PR

A-6	Z.S.CLR: Clear Fine Zero & Span Adjustment for PV display nonE Pv.Zro Pv.SPn both
A-7	dSPLY: Display Function Pv Mini.H MAx.H RS485
A-8	Lo.CUt: Low Cut Function -19999~+29999
A-9	AvG: Average update for PV 1(None)~ 99 times
A-10	M.AvG: Moving Average update for PV 1(None)~ 10 times
A-11	d.FiLT: Digital filter 0(None)/1~99 times
A-12	dn.KEY: Down key function nonE rEL.Pv Pv.HLd M.rSt rY.rSt
A-13	P.CodE: Pass Code for enter Programming Level 0000~9999
A-14	F.LoCk: Function Level Lock nonE USEr EnG ALL

➤ Plesae refer to operating manual for detail description