

CA/CV AC CURRENT / VOLTAGE Transducer

FEATURE

- FOR AC CURRENT 0~1/~5/~10A, VOLTS 0~150/~300/~500V
- 1Phase(1 I/O), 3Phases(3 I/O)
- Precision measurement even for distorted waveform
- Self powered or Loop powered models available
- Output signal programmable by dip-switch
- Low output ripple
- High impulse & Surge protection
- High stability & low cost



SPECIFICATION

INPUT: Current or Voltage

	AC Input	Input Burden	Input Frequency
Current	Aux. Powered & Loop Powered	0 ~ 1 A	50 Hz ± 3 Hz
		0 ~ 5 A	60 Hz ± 3 Hz
	Self Powered	0 ~ 10 A	≤ 0.10VA
		20%~100% of input range	≤ 1.50VA
Voltage	Aux. Powered & Loop Powered	0 ~ 150 V	50 Hz ± 3 Hz
		0 ~ 300 V	60 Hz ± 3 Hz
		0 ~ 500 V	≤ 0.15VA
	Self Powered	20%~100% of input range	≤ 4.00VA
			50 Hz ± 1 Hz
			60 Hz ± 1 Hz

OUTPUT: Current or Voltage O/P Programming by Dip Switch inside

Output Range	Load Resistance	Output Resistance	Output Ripple
0 ~ 1 V	≥ 500 Ω	≤ 0.001 Ω	≤ 0.2% R.O. Self-powered units can not be used for 4~20mA, 1~5V and 2~10V output.
0 ~ 5 V	≥ 500 Ω ; Self Powered: ≥ 2K Ω		
0 ~ 10 V	≥ 1000 Ω ; Self Powered: ≥ 2K Ω		
1 ~ 5 V	≥ 500 Ω		
2 ~ 10 V	≥ 1000 Ω		
0 ~ 1 mA	0 ~ 12K Ω	≥ 20M Ω	
0 ~ 10 mA	0 ~ 1200 Ω ; Self Powered: ≥ 500 Ω	≥ 6M Ω	
0 ~ 20 mA	0 ~ 600 Ω ; Self Powered: ≥ 500 Ω		
4 ~ 20 mA	0 ~ 600 Ω		
Loop Powered 4 ~ 20 mA	Vs / (20 mA) - 900 ohm		

※When Aux Powered is DC, The Load Resistance is about 70%

- Accuracy :** ≤ ±0.2% of F.S.
Self Powered ≤ ±0.2% of F.S
- Waveform effect (trms type):** ≤ 0.2% of F.S. at 30% distortion
- Max. input over capability:** Voltage: 1.5 x rated continuous
2 x rated for 10 seconds
4 x rated for 2 seconds
Current: 3 x rated continuous
10 x rated for 10 seconds
50 x rated for 1 second
- Response time:** ≤ 250 msec.
- Span adjustment:** ≤ ±5% of F.S. (or ±20% of F.S. specify)
- Zero adjustment:** ≤ ±2% of F.S. (or ±20% of F.S. specify)
- Output load effect:** Current output ≤ 0.1% of F.S.
Voltage output ≤ 0.05% of F.S.
- Power supply:** AC 115/230V ±15%, 50/60 Hz
AC 380 or 415V ±15%, 50/60 Hz
Option: DC 24V, 48V, 110V, 220V ±10%
Loop powered DC 18 ~ 32V
Self Powered: Not required
ADH: AC 85~264V, DC 100~300V
ADL: AC/DC 20~56V
- Power effect:** ≤ 0.05% of F.S.
- Power consumption:** ≤ 2.5VA (1P2W models) ≤ 6.5VA (3P3W models)
≤ 9 VA (ADH / ADL)
- Mutual interference effect:** ≤ 0.1% R.O. between each element
- Magnetic field strength:** 400ATM ≤ 0.2% of F.S.
- Operating temperature:** 0~60 °C
- Operating relative humidity:** 20~95 %RH, non-condensing
- Temperature coefficient:** ≤ 100 PPM/°C

- Storage temperature:** -10~70 °C
- Dielectric Strength:** IEC 414, IEC 688:1992, ANSI C37.90a
Between Input / Output / Power / Case
AC 4KV, 50/60Hz, 1 min.
- Surge test:** IEC 255-4, ANSI C37.90a
6KV, 1.2 x 50 usec.
Common mode & differential mode
≥ 100M ohm, DC 500V
- Insulation resistance:** IEC 414, BS 5458
- Safety:** IEC 529 (IP50)
- Enclosure:** Wall or DIN rail (EN 50022)
- Mounting:** 1P: under 450g, 3P: under 650g
- Weight:**

ADJUSTMENT

Volt or Current – 1 Phase

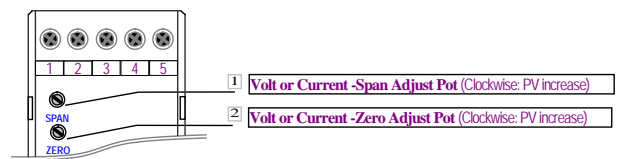

Volt or Current – 3 Phases

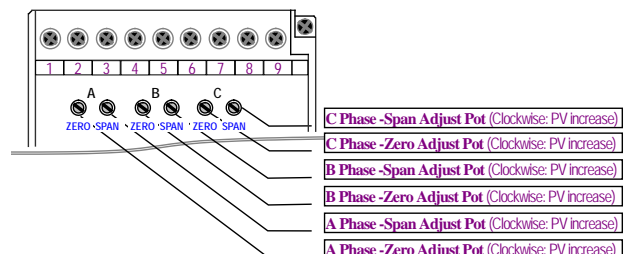

DIMENSIONS

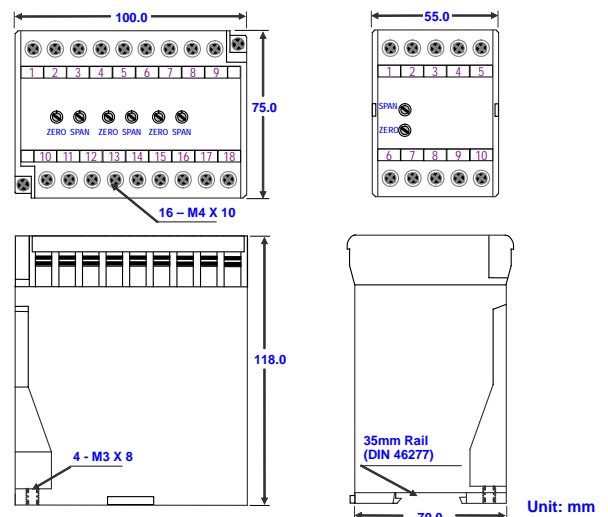

PANEL MOUNTING HOLES

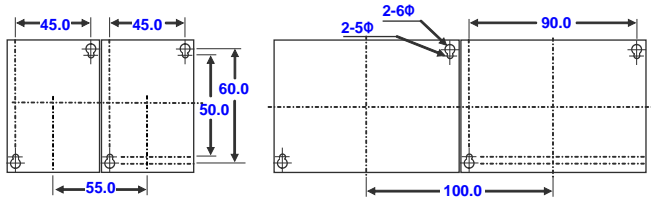

OUTPUT RANGE PROGRAMMING

OUTPUT	Dip Switch							
	1	2	3	4	5	6	7	8
0 ~ 1 mA					on			
0 ~ 10 mA					on	on		
0 ~ 20 mA					on		on	
4 ~ 20 mA	on				on		on	
0 ~ 1 V		on	on	on				on
0 ~ 5 V			on	on				on
0 ~ 10 V				on				on
1 ~ 5 V	on		on	on				on
2 ~ 10 V	on			on				on

* Pads: blank fields mean open.

CONNECTION DIAGRAM

1 Phase (Auxiliary Powered)

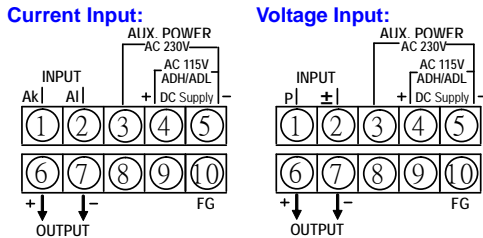

3 Phases (Auxiliary Powered)

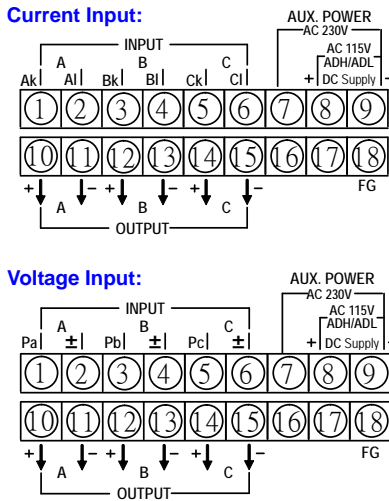

ORDERING INFORMATION

ADH&ADL only 1P2W can be selected

C Input Type — Connection — Input — Input Freq. — Output — Aux. Power

CODE	INPUT TYPE
A	Current (Avg.)
AT	Current (Trms)
V	Voltage (Avg.)
VT	Voltage (Trms)

CODE	CONNECTION
12	1Phase (1 I/O)
33	3Phase (3 I/O)

CODE	INPUT
A1	0 - 1 A
A5	0 - 5 A
AA	0 - 10 A
V1	0 - 150 V
V3	0 - 300 V
V5	0 - 500 V
AO	Specify (A i/p)
VO	Specify (V i/p)

CODE	INPUT FREQ.
5	50Hz ±3Hz
6	60Hz ±3Hz
F	Specify

CODE	OUTPUT RANGE
A1	0 - 1 mA
A2	0 - 5 mA
A3	0 - 10 mA
A4	0 - 20 mA
A5	4 - 20 mA
AO	Specify (mA o/p)

CODE	OUTPUT RANGE
V1	0 - 1 V
V2	0 - 5 V
V3	0 - 10 V
V4	1 - 5 V
VO	Specify (V o/p)

CODE	AUX. POWER
A1	AC 115/230 V
A2	AC 380 V
A3	AC 416 V
D2	DC 24 V
D4	DC 48 V
D1	DC 110 V
D3	DC 220 V
LP	Loop Powered
AS	Self Powered
DO	Specify DC
AO	Specify AC

* Self-powered units can not be used for 4~20mA, 1~5V and 2~10V output.

ADH	AC85-85-264 ; DC100-300V
ADL	AC/DC 20-56

TRMS measuring can not be used in Self Powered & Loop Powered type. And Loop Powered is only for 1 phase type.

1 Phase (Self Powered)

Current Input:

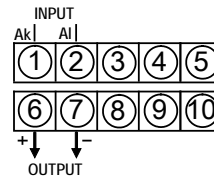

Voltage Input:

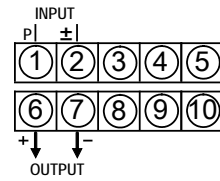

3 Phases (Self Powered)

Current Input:

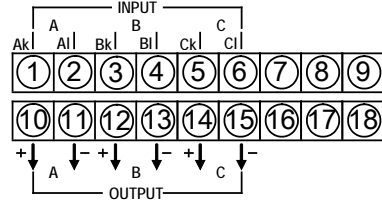

Voltage Input:

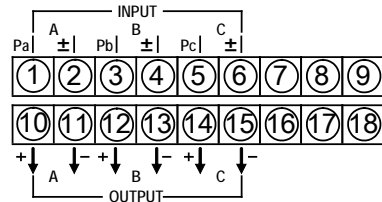

1 Phase (Loop Powered)

Current Input:

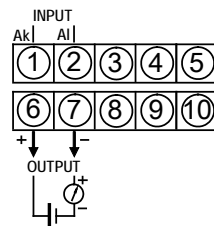

Voltage Input:

